



# WL4SL-3P2232

W4

MINIATURE PHOTOELECTRIC SENSORS

**SICK**  
Sensor Intelligence.



### Ordering information

Type	Part no.
WL4SL-3P2232	1061561

Other models and accessories → [www.sick.com/W4](http://www.sick.com/W4)

Illustration may differ



### Detailed technical data

#### Features

<b>Functional principle</b>	Photoelectric retro-reflective sensor
<b>Functional principle detail</b>	Without reflector minimum distance (autocollimation/coaxial optics)
<b>Sensing range max.</b>	0 m ... 12 m <sup>1)</sup>
<b>Sensing range</b>	0 m ... 8 m <sup>1)</sup>
<b>Polarisation filters</b>	Yes
<b>Emitted beam</b>	
Light source	Laser <sup>2)</sup>
Type of light	Visible red light
Light spot size (distance)	Ø 1 mm (500 mm)
<b>Key laser figures</b>	
Normative reference	EN 60825-1:2014, IEC 60825-1:2014 / CDRH 21 CFR 1040.10 & 1040.11
Laser class	1
Wave length	650 nm
<b>Adjustment</b>	Single teach-in button
<b>Special applications</b>	Detecting small objects
<b>Mounting hole</b>	M3

<sup>1)</sup> Reflector PL80A.

<sup>2)</sup> Average service life: 50,000 h at T<sub>U</sub> = +25 °C.

## Safety-related parameters

<b>MTTF<sub>D</sub></b>	616 years (EN ISO 13849-1) <sup>1)</sup>
<b>DC<sub>avg</sub></b>	0 %
<b>T<sub>M</sub> (mission time)</b>	10 years

<sup>1)</sup> Mode of calculation: Parts-Count-calculation.

## Electronics

<b>Supply voltage U<sub>B</sub></b>	10 V DC ... 30 V DC <sup>1)</sup>
<b>Ripple</b>	< 5 V <sub>pp</sub> <sup>2)</sup>
<b>Current consumption</b>	30 mA <sup>3)</sup>
<b>Protection class</b>	III
<b>Digital output</b>	
Type	PNP <sup>4)</sup>
Switching mode	Light/dark switching <sup>4)</sup>
Output current I <sub>max.</sub>	≤ 100 mA
Response time	≤ 0.5 ms <sup>5)</sup>
Switching frequency	1,000 Hz <sup>6)</sup>
<b>Output function</b>	Complementary
<b>Circuit protection</b>	A <sup>7)</sup> B <sup>8)</sup> C <sup>9)</sup>

<sup>1)</sup> Limit values when operated in short-circuit protected network: max. 8 A.

<sup>2)</sup> May not fall below or exceed U<sub>y</sub> tolerances.

<sup>3)</sup> Without load.

<sup>4)</sup> Q = light switching.

<sup>5)</sup> Signal transit time with resistive load.

<sup>6)</sup> With light/dark ratio 1:1.

<sup>7)</sup> A = V<sub>S</sub> connections reverse-polarity protected.

<sup>8)</sup> B = inputs and output reverse-polarity protected.

<sup>9)</sup> C = interference suppression.

## Mechanics

<b>Housing</b>	Rectangular
<b>Design detail</b>	Slim
<b>Dimensions (W x H x D)</b>	12.2 mm x 41.8 mm x 17.3 mm
<b>Connection</b>	Male connector M8, 4-pin
<b>Material</b>	
Housing	Plastic, Novodur
Front screen	Plastic, PMMA
<b>Weight</b>	100 g

## Ambient data

<b>Enclosure rating</b>	IP66
-------------------------	------

<sup>1)</sup> As of T<sub>a</sub> = 50 °C, a max. supply voltage V<sub>max.</sub> = 24 V and a max. load current I<sub>max.</sub> = 50 mA is permitted.

<sup>2)</sup> Operation below T<sub>u</sub> -10 °C is possible if the sensor is already switched on at T<sub>u</sub> > -10 °C, then cools down, and the supply voltage is subsequently not switched off. Switching on below T<sub>u</sub> -10 °C is not permissible.

	IP67
<b>Ambient operating temperature</b>	-10 °C ... +50 °C
<b>Ambient operating temperature extended</b>	-30 °C ... +55 °C <sup>1) 2)</sup>
<b>Ambient temperature, storage</b>	-30 °C ... +70 °C

<sup>1)</sup> As of  $T_a = 50\text{ °C}$ , a max. supply voltage  $V_{max.} = 24\text{ V}$  and a max. load current  $I_{max.} = 50\text{ mA}$  is permitted.

<sup>2)</sup> Operation below  $T_u - 10\text{ °C}$  is possible if the sensor is already switched on at  $T_u > -10\text{ °C}$ , then cools down, and the supply voltage is subsequently not switched off. Switching on below  $T_u - 10\text{ °C}$  is not permissible.

### Classifications

<b>ECLASS 5.0</b>	27270902
<b>ECLASS 5.1.4</b>	27270902
<b>ECLASS 6.0</b>	27270902
<b>ECLASS 6.2</b>	27270902
<b>ECLASS 7.0</b>	27270902
<b>ECLASS 8.0</b>	27270902
<b>ECLASS 8.1</b>	27270902
<b>ECLASS 9.0</b>	27270902
<b>ECLASS 10.0</b>	27270902
<b>ECLASS 11.0</b>	27270902
<b>ECLASS 12.0</b>	27270902
<b>ETIM 5.0</b>	EC002717
<b>ETIM 6.0</b>	EC002717
<b>ETIM 7.0</b>	EC002717
<b>ETIM 8.0</b>	EC002717
<b>UNSPSC 16.0901</b>	39121528

### Connection diagram

Cd-083

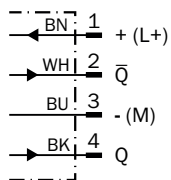

Characteristic curve

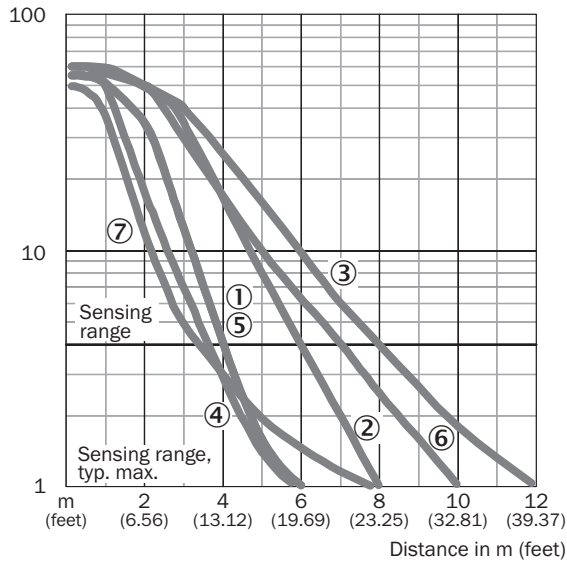

- ① Reflector PL20A
- ② Reflector PL40A
- ③ Reflector PL80A
- ④ PL10F reflector
- ⑤ Reflector PL20F
- ⑥ Reflector P250F
- ⑦ Reflective tape REF-AC1000

Light spot size

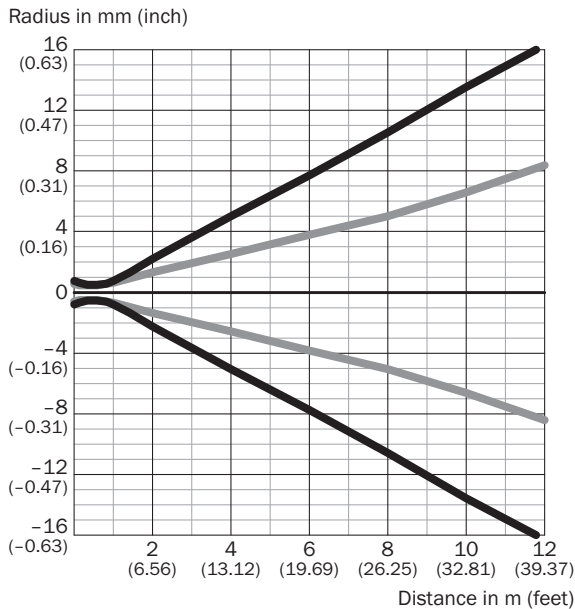

Dimensions in mm (inch)

Sensing range	Vertical	Horizontal
<b>0.5 m</b> <b>(1.64 feet)</b>	< 1.0 (0.04)	< 1.0 (0.04)
<b>1 m</b> <b>(3.28 feet)</b>	1.5 (0.06)	1.2 (0.05)
<b>6 m</b> <b>(19.69 feet)</b>	15.2 (0.60)	7.6 (0.30)
<b>12 m</b> <b>(39.37 feet)</b>	32.4 (1.28)	16.4 (0.65)

— Vertical  
— Horizontal

### Light spot size (detailed view)

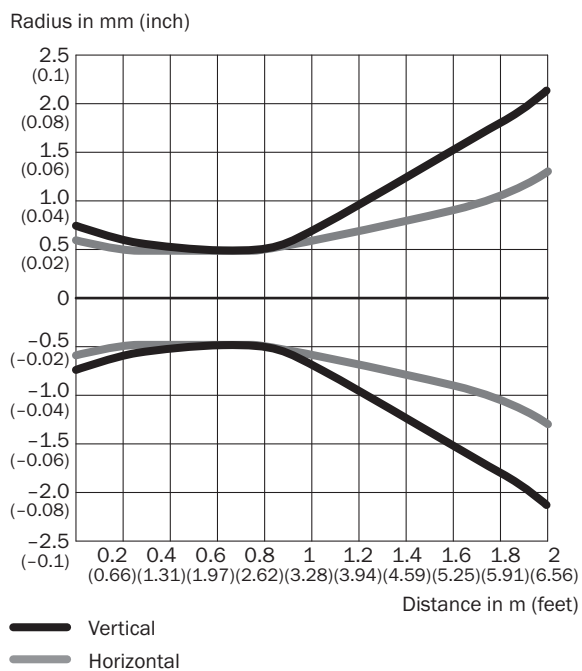

### Sensing range diagram

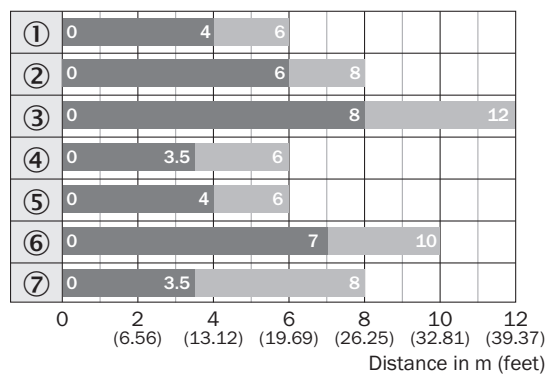

- ① Reflector PL20A
- ② Reflector PL40A
- ③ Reflector PL80A
- ④ PL10F reflector
- ⑤ Reflector PL20F
- ⑥ Reflector P250F
- ⑦ Reflective tape REF-AC1000

Dimensional drawing (Dimensions in mm (inch))

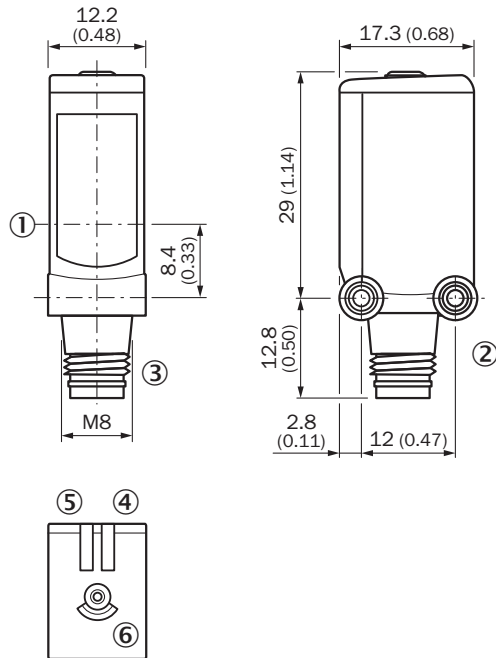

WL4SL-3, WL4SLG-3, WSE4SL-3, plug



- ① Center of optical axis
- ② Threaded mounting hole M3
- ③ Connection
- ④ LED indicator green: Supply voltage active
- ⑤ LED indicator yellow: Status of received light beam
- ⑥ Single teach-in button

Recommended accessories

Other models and accessories → [www.sick.com/W4](http://www.sick.com/W4)

	Brief description	Type	Part no.
Others			
	<ul style="list-style-type: none"> <li><b>Description:</b> Fine triple reflector, screw connection, suitable for laser sensors</li> <li><b>Dimensions:</b> 20 mm 32 mm</li> <li><b>Ambient operating temperature:</b> -30 °C ... +65 °C</li> </ul>	PL10F	5311210
	<ul style="list-style-type: none"> <li><b>Connection type head A:</b> Female connector, M8, 4-pin, straight, A-coded</li> <li><b>Connection type head B:</b> Flying leads</li> <li><b>Signal type:</b> Sensor/actuator cable</li> <li><b>Cable:</b> 5 m, 4-wire, PVC</li> <li><b>Description:</b> Sensor/actuator cable, unshielded</li> <li><b>Application:</b> Zones with chemicals, Uncontaminated zones</li> </ul>	YF8U14-050VA3XLEAX	2095889
	<ul style="list-style-type: none"> <li><b>Connection type head A:</b> Male connector, M8, 4-pin, straight, A-coded</li> <li><b>Description:</b> Unshielded</li> <li><b>Connection systems:</b> Screw-type terminals</li> <li><b>Permitted cross-section:</b> 0.14 mm² ... 0.5 mm²</li> </ul>	STE-0804-G	6037323

## SICK AT A GLANCE

SICK is one of the leading manufacturers of intelligent sensors and sensor solutions for industrial applications. A unique range of products and services creates the perfect basis for controlling processes securely and efficiently, protecting individuals from accidents and preventing damage to the environment.

We have extensive experience in a wide range of industries and understand their processes and requirements. With intelligent sensors, we can deliver exactly what our customers need. In application centers in Europe, Asia and North America, system solutions are tested and optimized in accordance with customer specifications. All this makes us a reliable supplier and development partner.

Comprehensive services complete our offering: SICK LifeTime Services provide support throughout the machine life cycle and ensure safety and productivity.

For us, that is “Sensor Intelligence.”

## WORLDWIDE PRESENCE:

Contacts and other locations –[www.sick.com](http://www.sick.com)